

Instruction Manual FH



Thank you for buying a SAUTER force gauge. We hope you are pleased with your high quality force gauge with its big functional range. If you have any queries, wishes or helpful suggestions, do not hesitate to call our service number.

„Sensor Outside“ means the cell is outside the body.

1. Included in Delivery

- SAUTER FH, incl. rechargeable battery
- Carrying Case
- Charger
- 5 pcs. M3x 8 screws

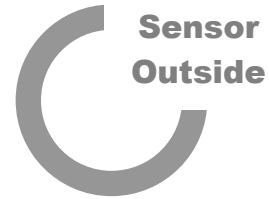
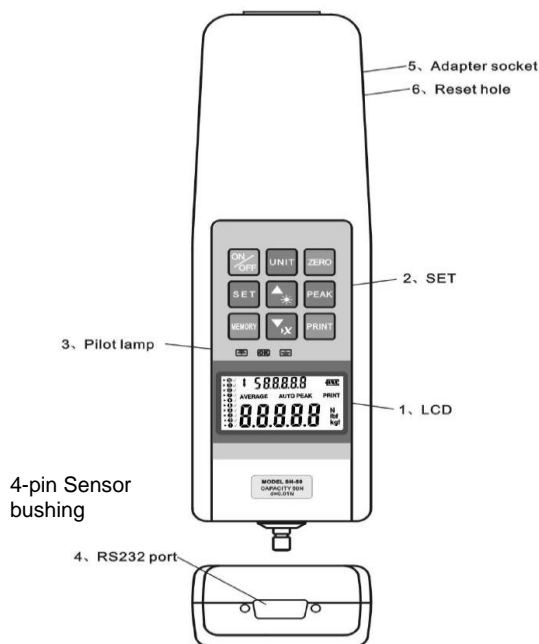

Important annotation:

By pressing the **RESET key** (on the right side of housing, see illustration on the left), individual settings and memorised values can be re-set or erased, in example for a new start of the instrument after an operating error.

Data in mm

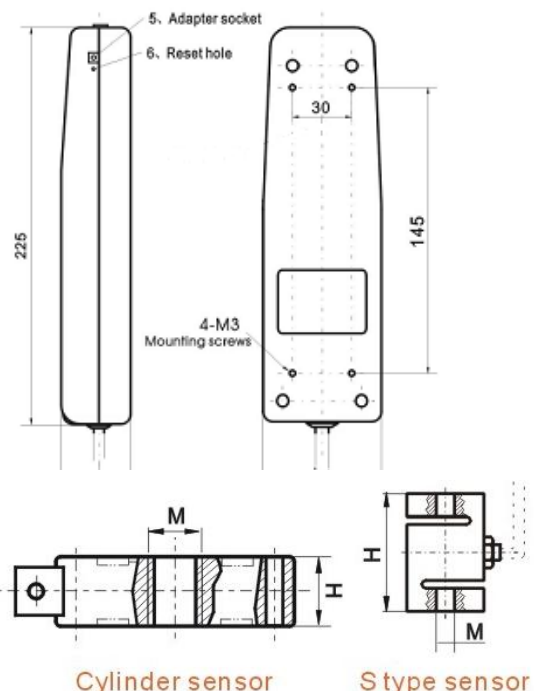

Length of cable between display and sensor: 2500 mm

Measurement Terms:

- Track = continuous measurement
- Peak = Capture of the maximum value

Dimensions of Sensors (from FH200k on inquiry)

2. Working Conditions

10°C to 30°C / 15% up to 80% humidity

Instruction Manual FH

3. Electrical Power Supply

Either by rechargeable battery or current power supply

Current power supply:

- Connection by power adapter
- Rechargeable batteries are charged simultaneously

Rechargeable battery pack for mobile applications:

- Type: Ni 8.4V / 600 mAh
- Charging time: approx 1 hour

4. Technical Data

- Accuracy: $\pm 0,5\%$ of Capacity
- Data Sampling Rate: 2.000 Hz
- Weight: 640 g

5. Operation

Display

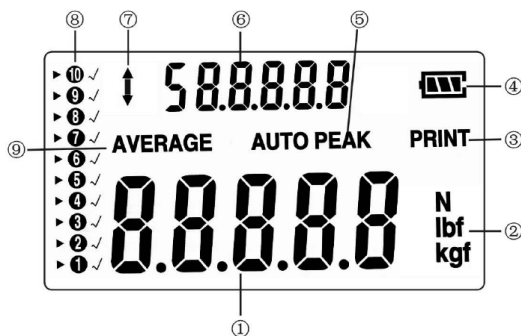

- (1) Measuring Result
- (2) Measuring Units
- (3) Activation of PRINT Function
- (4) Indication of power charging status
PEAK or AUTO-PEAK Mode
- (5) Average value of stored peak values
- (6) Force direction
- (7) Occupancy of storing spaces
- (8) AVERAGE- or Saving Mode

Operating keys

ON / OFF:



ON / OFF key
(For ON, press 1 sec.)

UNIT:



- Press short: Select unit:
N, kg or lb
- Press for 2 sec.: Display return

ZERO:



Three functions:

- Zeros the measuring result (Tara function)
- Cleans the peak value (in Peak mode)
- Saves a setting (in SET mode)

SET:



- 1 x Press: Upper Limit [HiLT / Hi Lt]. To change press: \blacktriangle or \blacktriangledown (see section High/Low Limit function)

Hi Lt



- 1 x Press: Lower Limit [Lo dT]. To change press \blacktriangle or \blacktriangledown (see section High/Low Limit function)

Lo dT



- 1 x Press: Minimum limit to save peak values in the instrument's memory. [LE.SET / Lo Pe]. Please see section „Min Limit Peak Save“. To change press: \blacktriangle or \blacktriangledown (Only in „Peak-Mode“ active) (see section min. limit peak save)

Lo Pe



- 1 x Press: Sets the Auto-STOP force value that stops the movement of a test stand. Adjustment of the force value. To change press: \blacktriangle or \blacktriangledown (only active in „Battery-Mode“)

StoP



- 1 x Press: Sets the AUTO-OFF force value that stops the movement of a test stand. To change press: \blacktriangle or \blacktriangledown (Only in „Battery-Mode“ active)

P.OFF



- 1 x Press: Peak-Freeze-Time [PE.2E / A.PE / HoldT]: Time period in which a peak value is being shown in the display in sec. To change press: \blacktriangle or \blacktriangledown

Instruction Manual FH

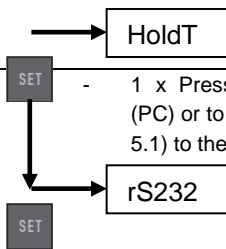

- 1 x Press: Data Transfer [rS232] to PC (PC) or to the printer (Print) or (in version U 5.1) to the test stand (stand)

- PC: Pressing SET once: Saves the Settings
- PRINT: Pressing SET twice: sending data to the printer
- STAND: Pressing SET three times: sending a signal to the Test Stand to stop its movement (in version U 5.1)

Back Light: 

PEAK: 

Three functions

- Track mode (continuous measurement)
- Peak mode (capture of maximum values)
- Auto-Peak mode, same as Peak-mode, only without the „Min limit peak save“ function

MEMORY:



Saves the peak values to calculate the average value (please see section „Memory mode“)

DELETE Function



Deletes stored peak values (only in „Memory mode“ active)

PRINT:



Sends the stored peak values to a PC or Printer (please see section „Data Output“)

High / Low limit function



LEDs to display OK / NOT OK Tests

- ▼ Lower than lower limit
- OK OK
- ▲ Higher than higher limit

This function allows efficient testing of OK / NOT OK measurements of similar or identical testing objects. A lower and an upper limit value can be defined. The instrument compares the individual measuring results with these limit values and shows the OK or NOT OK result by green or red light diode and by sound.

To set these limit values, please see the SET Menu in section „Operating keys“.

Measurement (Track Modus)

Display (1) shows the continuous force in a defined direction (6)

To zero the display, press:



Peak-Hold Function (Peak Mode)

Please press:



Auto-Peak-Hold-Function(Auto-Peak Mode)

Please press:



Min. limit peak save

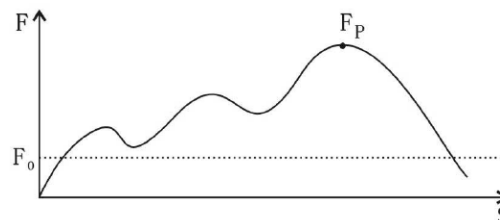

This function allows to eliminate unwanted „Pre-Peak values“ that are lower than the main peak value (Fp). The „Min limit peak save“ value (Fo) takes care, that these „Pre-Peak values“ are not saved.

The „Min limit peak save“ function is only possible in Peak-Mode.

To set this Min limit value, please see the SET Menu in section „Operating keys“.

Memory mode and average value (from up to 10 peak values)

Saving peak values in the instrument

- ⇒ Activating the „AUTO PEAK Function“ by PEAK key
- ⇒ Deactivating the „Average Function“ by MEMORY key
- ⇒ Now, all peak values are stored automatically in the instrument

Instruction Manual FH

- ⇒ To browse through the stored values, please use the ▲ or ▼ keys. (The values will be shown in the upper display segment)
- ⇒ By pressing the MEMORY key, the average value of the stored peak values can be shown (in the upper display segment)
- ⇒ To delete every stored value, press the ▼-key in the AVERAGE-Mode

The instrument you have acquired serves to determine the measuring value of the material to be measured. It is intended to be used as a "non-automatic" instrument, i.e. the material to be measured is manually and carefully attached at the instrument. The measuring value can be read off after a stable measuring value has been obtained.

Inappropriate use

Do not use the instrument for medical measurements. In the case that small quantities are removed or added to the material to be measured, incorrect measuring results can be displayed due to the "stability compensation" inside of the instrument. (Example: Slow draining off of liquid from a container suspended from the instrument). Do not attach a continuous load. This can damage the measuring unit as well as the parts, relevant to safety.

Prevent jolts, torsion and oscillation (e.g. by appending slopingly) of all kinds. Be sure to prevent overloading the instrument in excess of the stated maximum load (max.), minus any tare weight that may possibly exist. This could damage the instrument (risk of breakage).

Important:

- Always make sure that there are no people or materials below the load that could be injured or damaged!
- The instrument is not suitable for measuring people. Do not use as baby scales!
- The instrument does not comply with the medical product law (MPG).

Never operate the instrument in hazardous locations. The series design is not explosion-proof. Structural alterations may not be practised to the instrument. This can lead to incorrect measuring results, faults concerning safety regulations as well as to destruction of the instrument. The instrument may only be used in compliance with the described guidelines. Varying areas of application/ planned use must be approved by SAUTER in writing.

Guarantee

The guarantee is not valid following

- non-observation of our guidelines in the operating instructions
- alteration to or opening of the device
- mechanical damage and damage caused by media, liquids
- natural wear and tear
- inappropriate erection or electric installation
- overloading of the measurement equipment

6. Configuration of RS 232

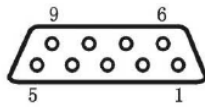

SUB-D 9pm

Pin	Signal	Illustration
2	TxD	Output signal
3	RxD	Input signal
5	GND	Ground
6	+1.6 to + 2 V	Over upper limit
7	+1.6 to + 2 V	Lower than lower limit
8	+1.6 to + 2 V	OK

6.1 Output Protocol

RS-232 Parameter

Baud rate: 9600
Data-Bit: 8
Parity: none
Stop-Bit: 1

The measured value is requested by the PC by the ASCII Sign "9".

The measured value that comes from the instrument has this format:

e.g. 0011.70 means -11,70 Newton, if Newton is the selected unit

||-----|
| |____> the other 6 places describe the measured value as ASCII-Signs
|____> the first place describes the direction of the force (0 = minus = Pressure; 1 = plus = Tension)

or: 1021.15 means +21,15 N (Tension)

7. Warning

Intended use

Monitoring the test substances

The metrology features of the instrument and any possible available adjusting weight must be checked at regular

Instruction Manual FH

intervals within the scope of quality assurance. For this purpose, the answerable user must define a suitable interval as well as the nature and scope of this check. Information is available on the home page (www.KERN-sohn.com) with regard to the monitoring of instrument test substances and the test weights required for this. Test weights and instruments can be adjusted quickly and at a reasonable price in KERN's accredited DKD calibration laboratory (return to national normal).

Fundamental safety information

Do not use the hanging instrument to transport loads. Prevent jolts, torsion and oscillation (e.g. by appending slopingly) of all kinds. Never use the hanging instrument over the maximum permitted weight (!!Danger of breaking!!). Always make sure that there are no living beings or materials below the load that could be injured or damaged. The hanging electronic instruments from the SAUTER instrument are only suitable for hand-held use or use in a test stand. They are not suitable for hanging from a mechanical hook, e.g. a crane hook.

Observe the information in the operating instructions Please read the operating instructions carefully before setting up and commissioning, even if you already have gained experience with SAUTER instruments.

Staff training

The device may only be operated and looked after by trained members of staff.

Major display deviations (incorrect measuring results) are possible if electromagnetic fields occur as well as due to static charging and instable power supply. It is then necessary to change the location.

Unpacking

Carefully remove the instrument from its packaging, remove the plastic wrapping and position the instrument in its intended working location.

8. CE Declaration of conformity



SAUTER GmbH
 D-72458 Albstadt
 E-Mail: info@sauter.eu
 Tel: 0049-[0]7431- 938-666
 Fax: 0049-[0]7431-938-292
 Internet: www.sauter.eu

Konformitätserklärung

Declaration of conformity for apparatus with CE mark
 Konformitätserklärung für Geräte mit CE-Zeichen
 Déclaration de conformité pour appareils portant la marque CE
 Declaración de conformidad para aparatos con marca CE
 Dichiarazione di conformità per apparecchi contrassegnati con la marcatura CE

English We hereby declare that the product to which this declaration refers conforms with the following standards.
 Deutsch Wir erklären hiermit, dass das Produkt, auf das sich diese Erklärung bezieht, mit den nachstehenden Normen übereinstimmt.
 Français Nous déclarons avec oela responsabilité que le produit, auquel se rapporte la présente déclaration, est conforme aux normes citées ci-après.
 Español Manifestamos en la presente que el producto al que se refiere esta declaración est''a de acuerdo con las normas siguientes
 Italiano Dichiariamo con ciò che il prodotto al quale la presente dichiarazione si riferisce è conforme alle norme di seguito citate.

Digital Push Pull Gauge: SAUTER FH

Mark applied	EU Directive	Standards
CE	89/336EEC EMC	EN 61326 : 1998 +A1:1998 +A2:2001

Date: 01.10.2006

Signature: 
 SAUTER GmbH
 Management

SAUTER GmbH, Schumannstrasse 33, D-72458 Albstadt, Tel: +49 (0) 7431 938 666, Fax: +49 (0) 7431 938 292

Instruction Manual FH

FH Adjustment Procedure

- | | | | |
|---|--|--|---|
| 1 | Start the instrument | Press ON/OFF | The green light is on |
| 2 | Enter the adjustment procedure | Directly after pressing ON/OFF, press PEAK and PRINT together for more times and very short intervals until the red light is on. | The lower red light is on |
| 3 | Instrument Type | Press SET
Directly after pressing PEAK + PRINT | XXX N is shown |
| a | <i>(Back to the normal mode ???)</i> | <i>(If you are in the operation mode again, the instrument has to be shut off. Start again with 1. Eventually pressing the buttons faster)</i> | |
| 4 | Select the instrument type | Press ▼▲ | The corresponding value to the instr. appears in the display |
| 5 | Save instrument type | Press SET | |
| 6 | Enter the adjustment sequence | Press MEMORY | The upper red light is on |
| 7 | Choose the adjustment weight | Press UNIT and with ▼▲ specify the calibration weight in Newton (X kg * 9,81) | The weight is written in the display |
| 8 | Save the adjustment weight | Press SET and UNIT simultaneously | |
| 9 | Attach the weight to the instrument (by hanging) | Press ZERO | The instrument changes to operation mode.
Adjustment procedure is finished |